

# INTERSECTION DRAWINGS CLASSIC TILE

## EAVES FLASHING

SCALE 1:5

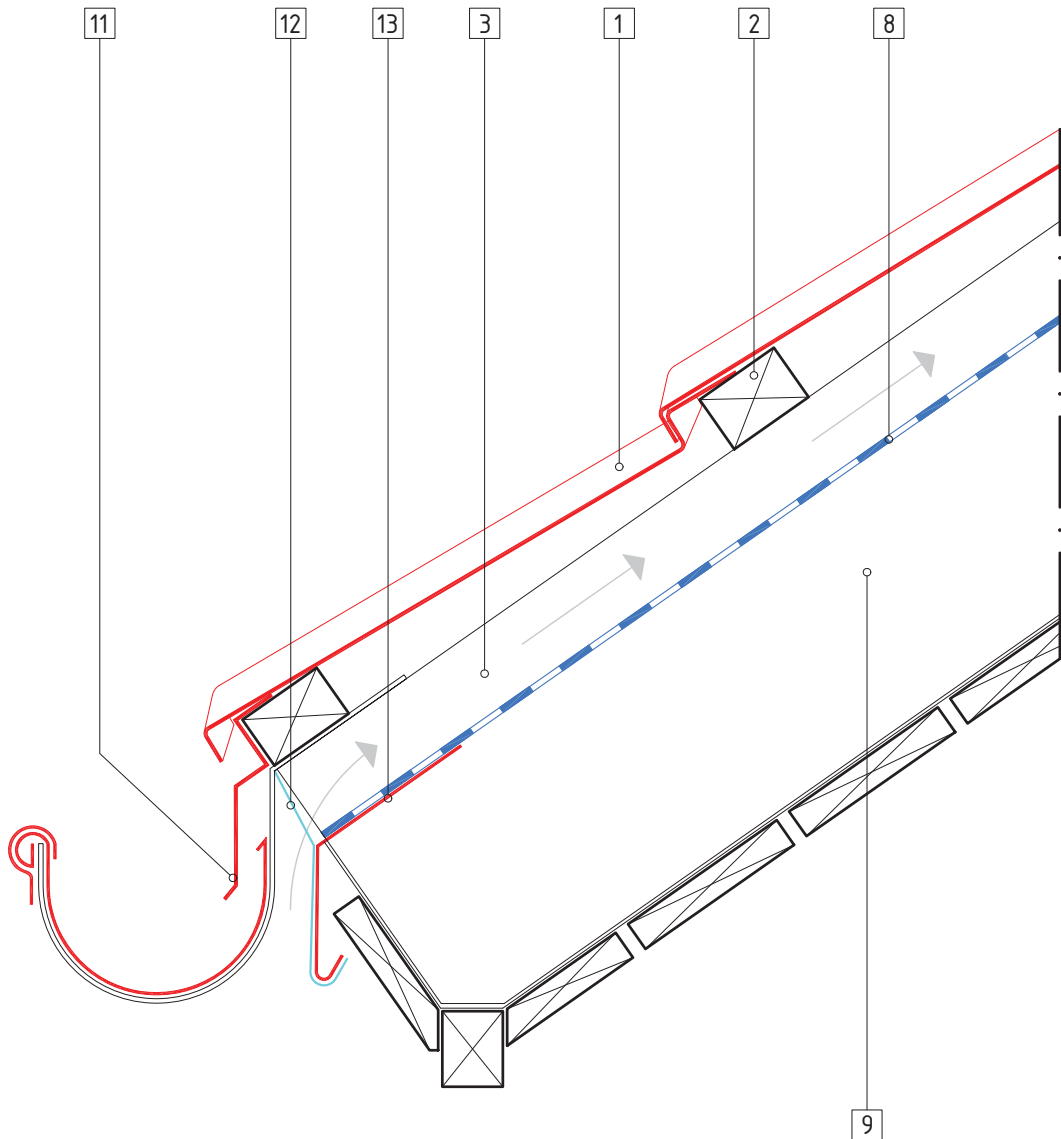

- 1 Tile
- 2 Tile Batten
- 3 Ventilation Space Batten
- 8 Underlay
- 9 Rafter
- 11 Eaves Flashing
- 12 Mesh
- 13 Eaves Guard Flashing

# INTERSECTION DRAWINGS CLASSIC TILE

BOX BARGE

SCALE 1:5

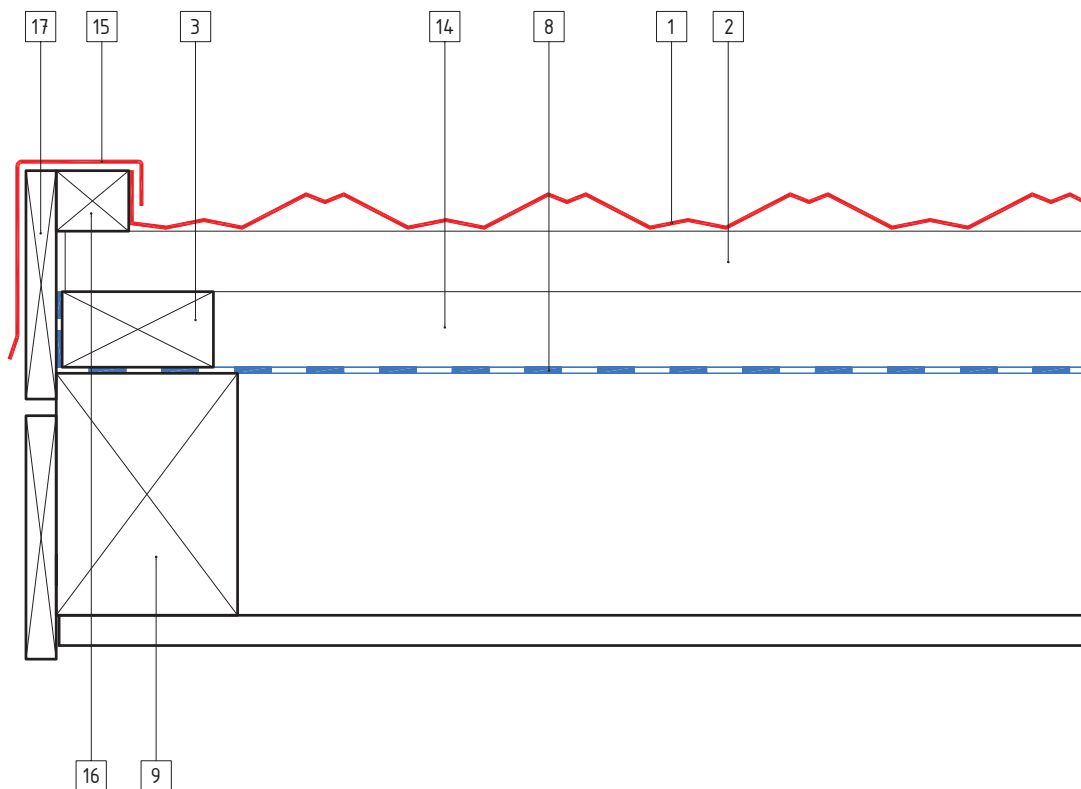

- 1 Tile
- 2 Tile Batten
- 3 Ventilation Space Batten
- 8 Underlay
- 9 Rafter
- 14 Ventilation Space
- 15 Box Barge
- 16 Gable Batten
- 17 Barge Board

# INTERSECTION DRAWINGS CLASSIC TILE

BASIC PRINCIPLE 1

SCALE 1:5

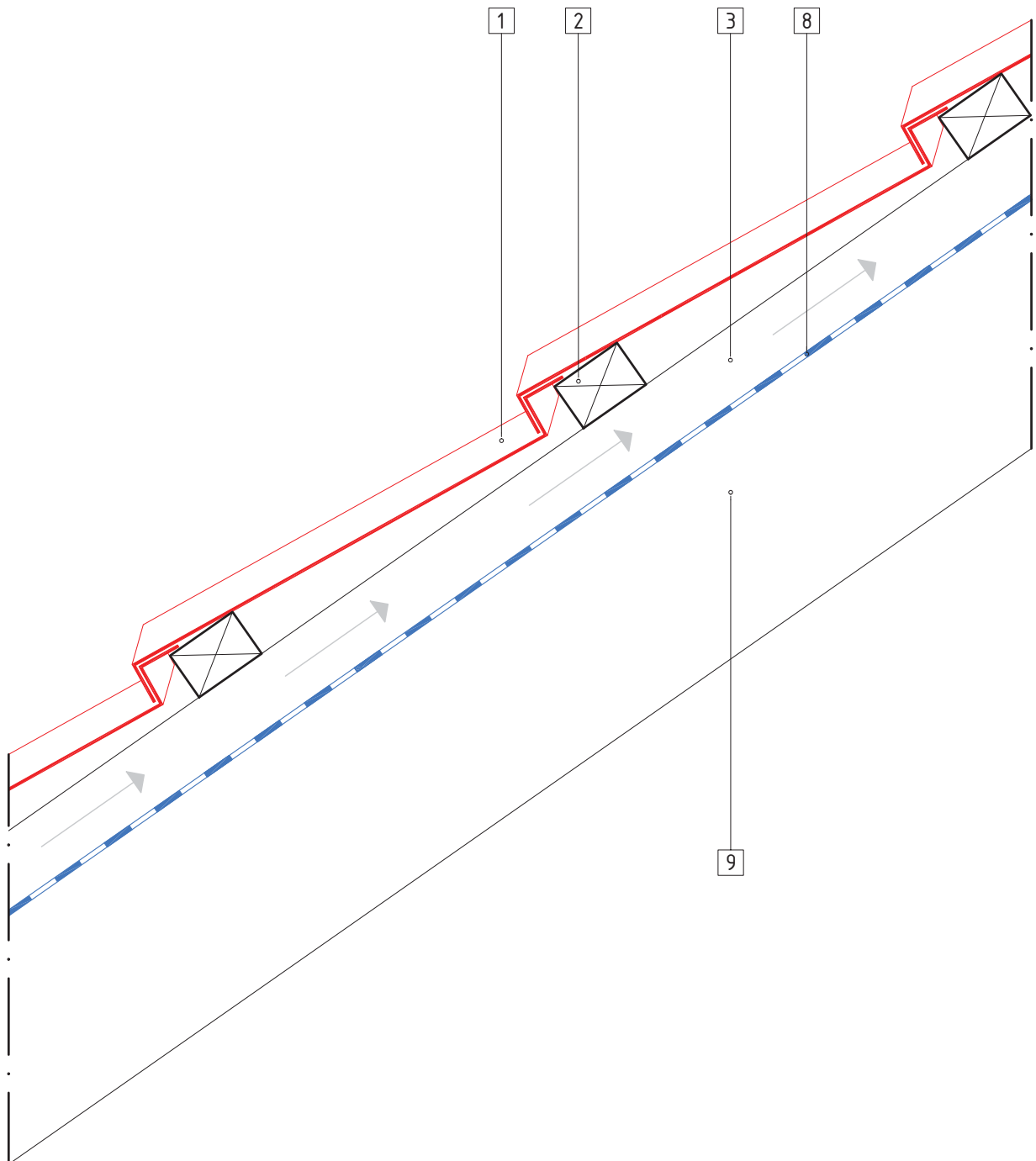

- 1** Tile
- 2** Tile Batten
- 3** Ventilation Space Batten
- 8** Underlay
- 9** Rafter

# INTERSECTION DRAWINGS CLASSIC TILE

BASIC PRINCIPLE 2

SCALE 1:5

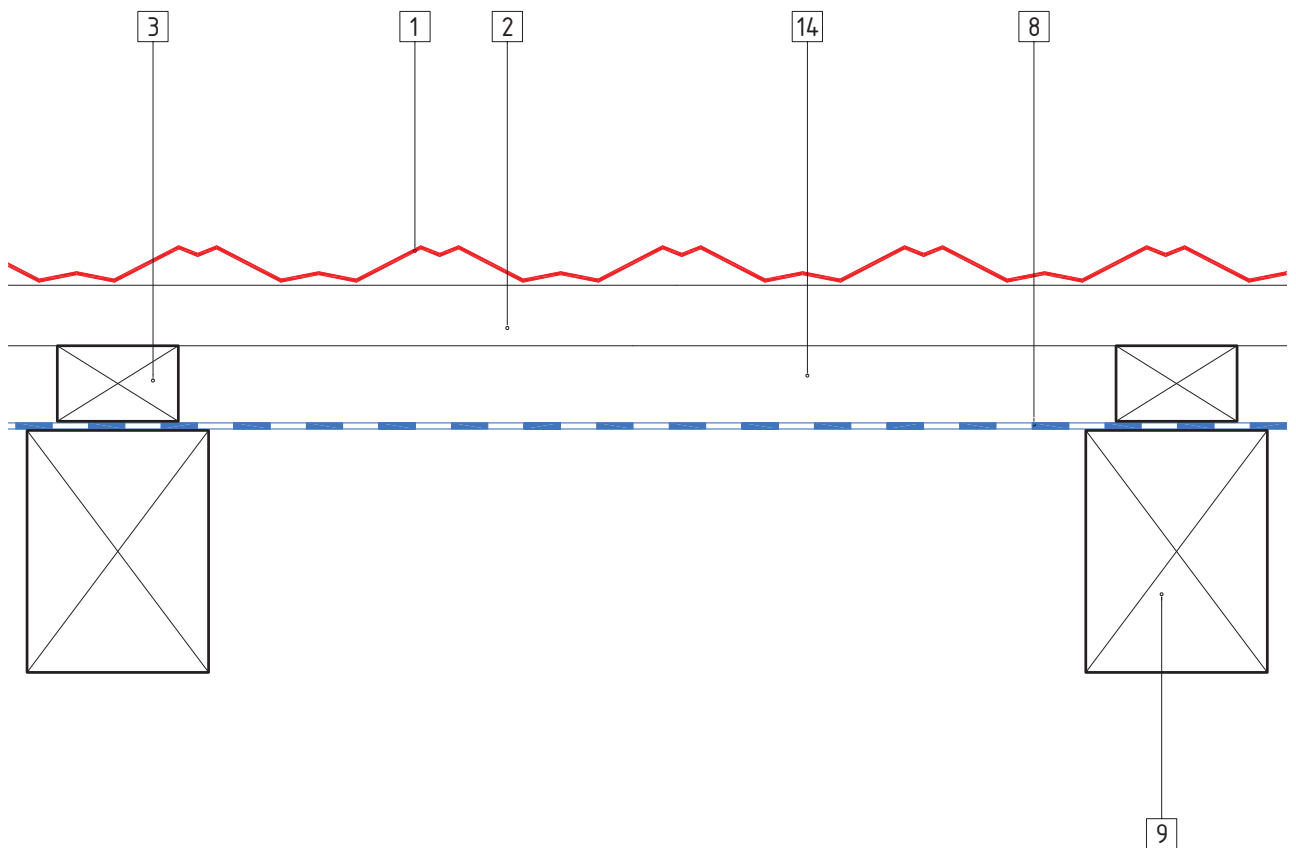

- 1** Tile
- 2** Tile Batten
- 3** Ventilation Space Batten
- 8** Underlay
- 9** Rafter
- 14** Ventilation Space

# INTERSECTION DRAWINGS CLASSIC TILE

RIDGE

SCALE 1:5

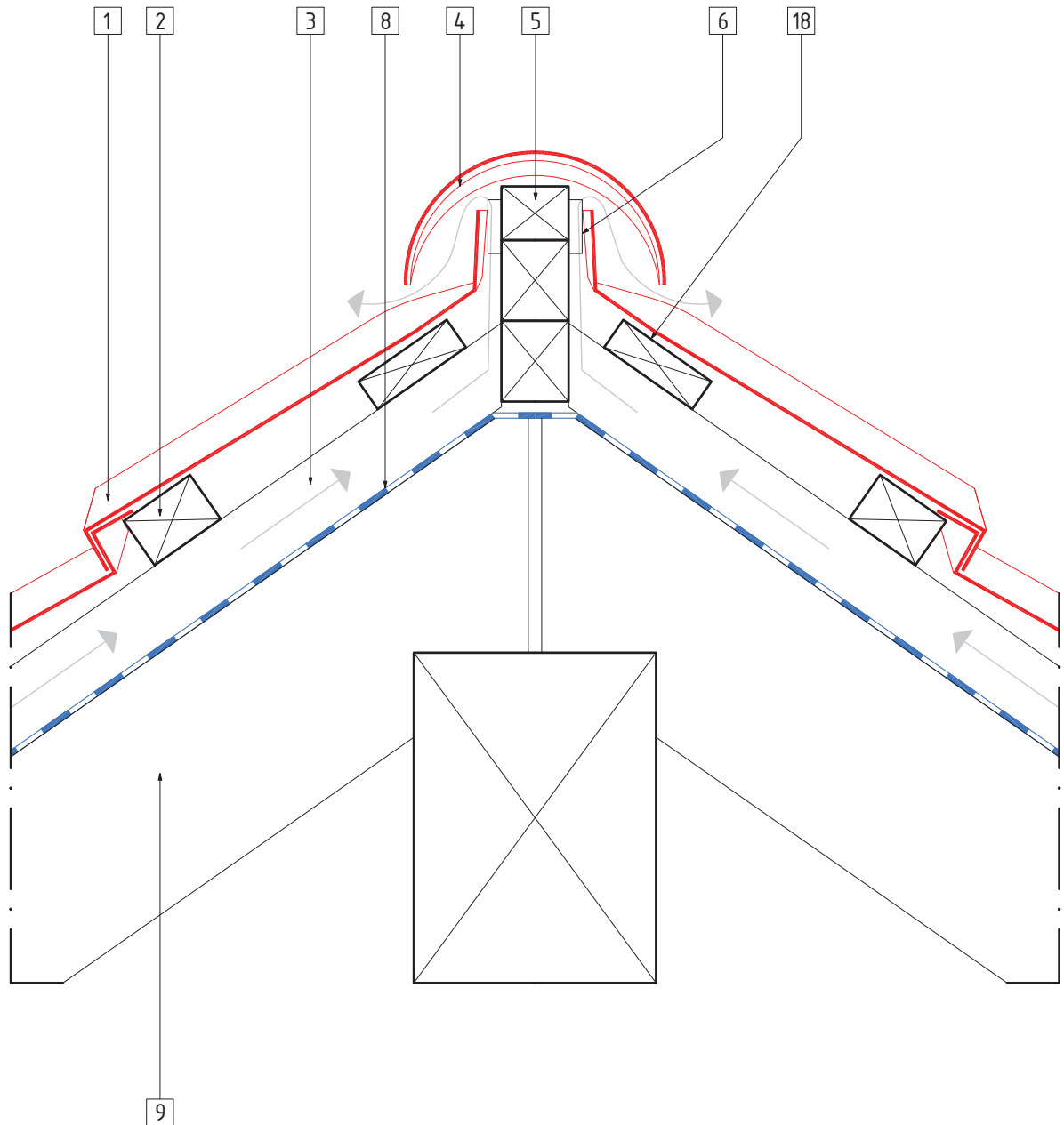

- 1 Tile
- 2 Tile Batten
- 3 Ventilation Space Batten
- 4 Barrel
- 5 Ridge Batten
- 6 Spacer
- 8 Underlay
- 9 Rafter
- 18 Thinner Support Batten

# INTERSECTION DRAWINGS CLASSIC TILE

RIDGE 1

SCALE 1:5

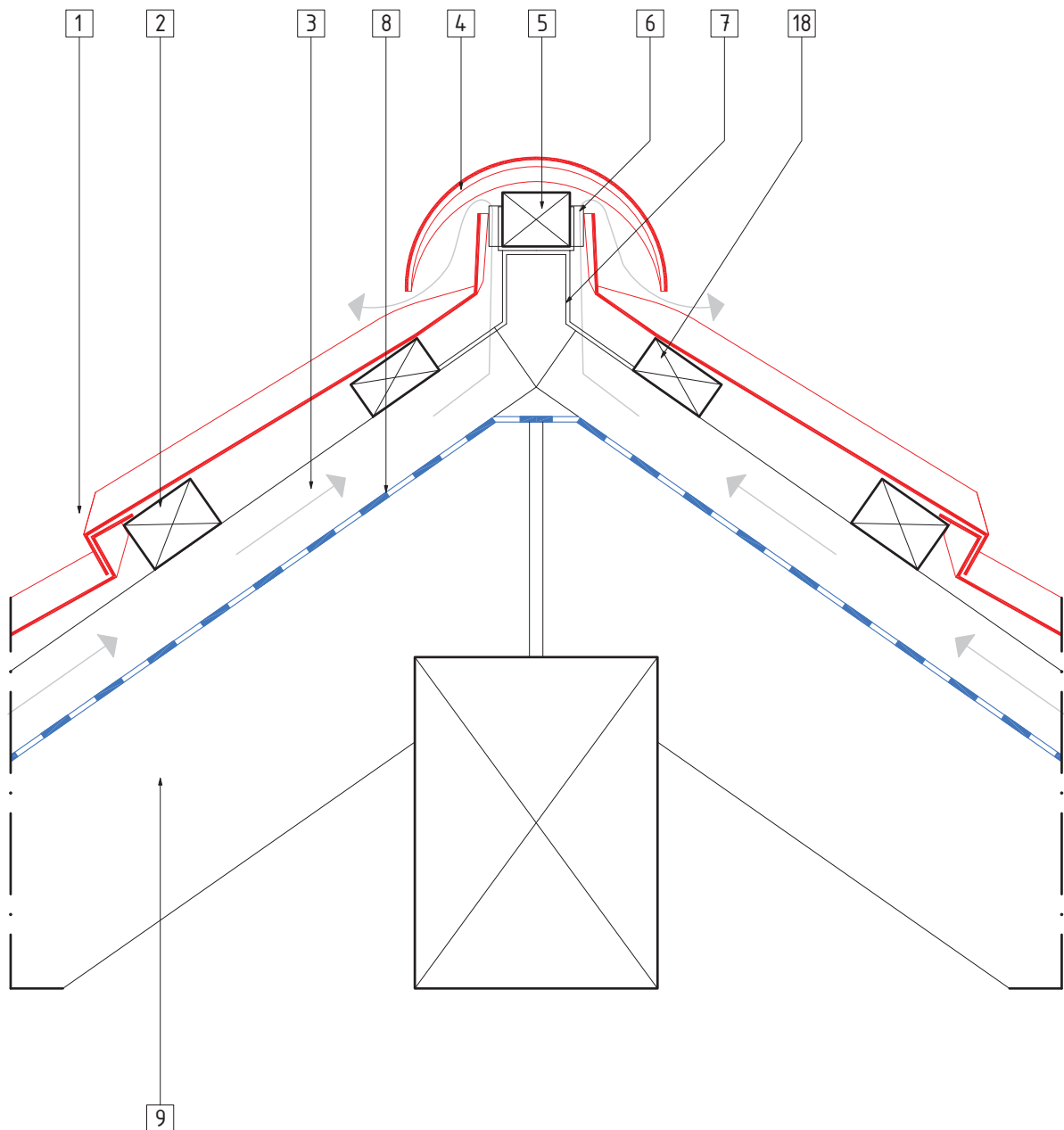

- 1 Tile
- 2 Tile Batten
- 3 Ventilation Space Batten
- 4 Batten
- 5 Ridge Batten
- 6 Spacer
- 7 Ridge Bracket
- 8 Underlay
- 9 Rafter
- 18 Thinner Support Batten

# INTERSECTION DRAWINGS CLASSIC TILE

VALLEY

SCALE 1:5

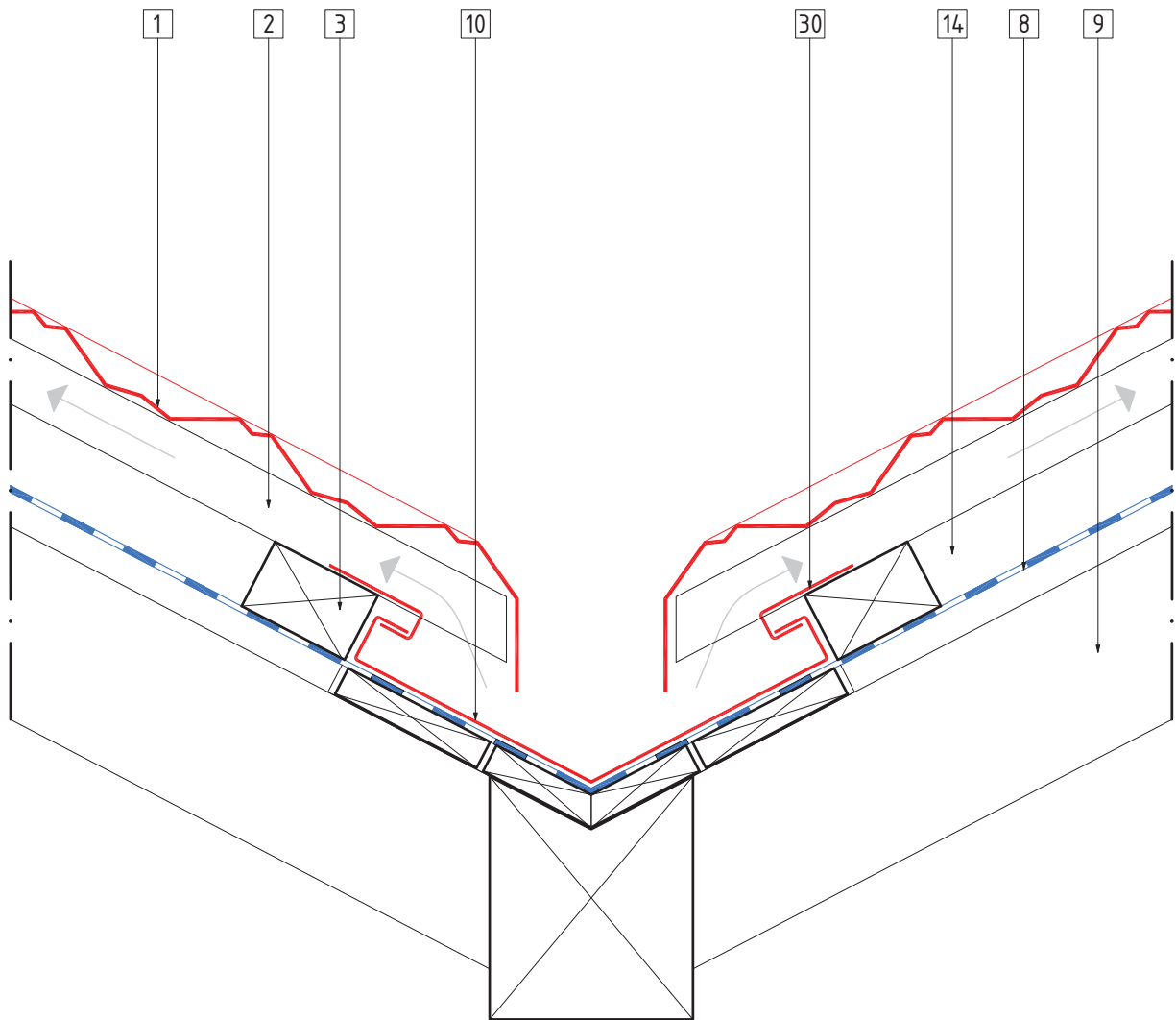

- 1 Tile
- 2 Tile Batten
- 3 Ventilation Space Batten
- 8 Underlay
- 9 Rafter
- 10 Valley
- 14 Ventilation Space
- 30 Clip

# INTERSECTION DRAWINGS CLASSIC TILE

VALLEY 1

SCALE 1:5

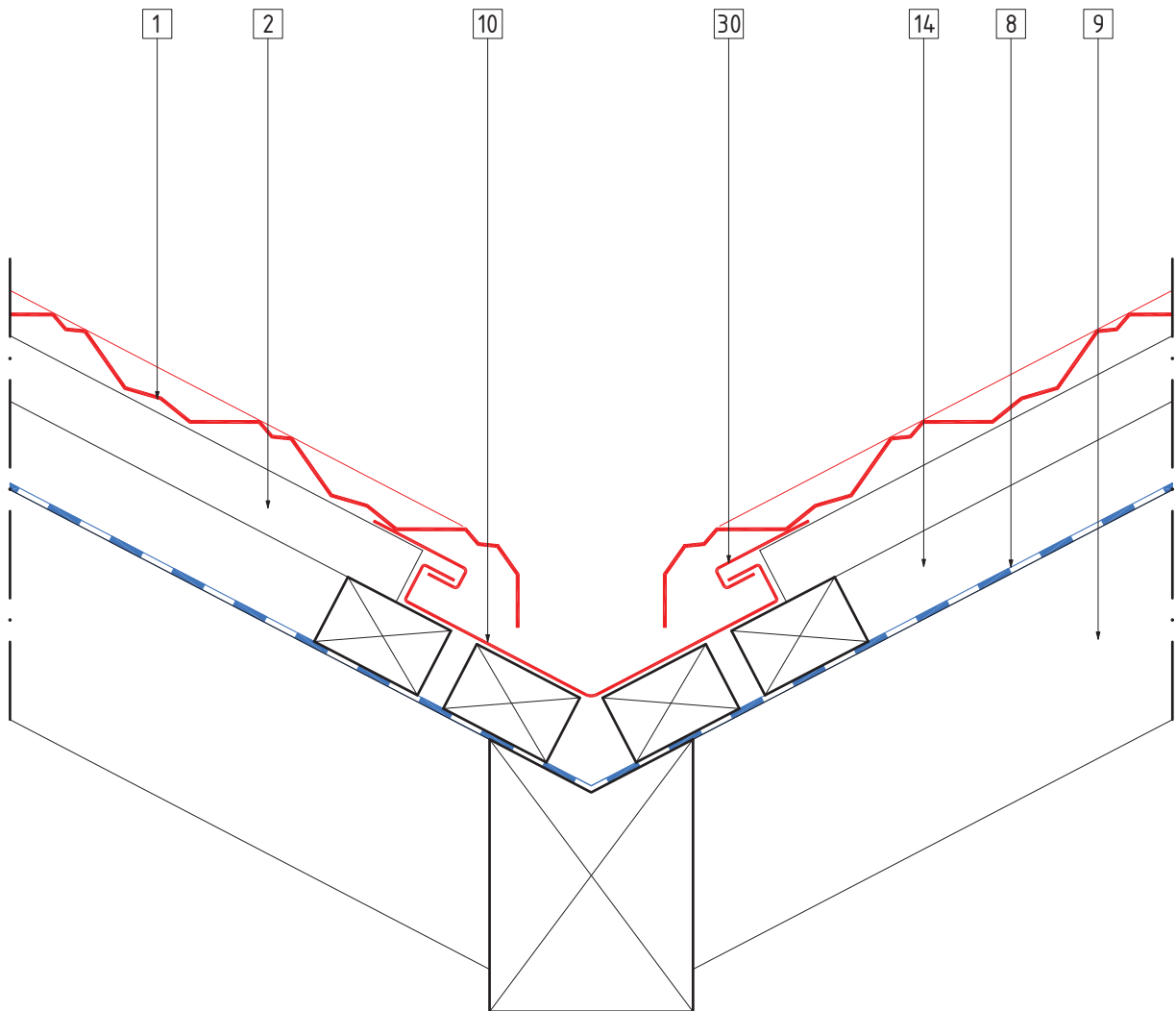

- 1 Tile
- 2 Tile Batten
- 3 Ventilation Space Batten
- 8 Underlay
- 9 Rafter
- 10 Valley
- 14 Ventilation Space
- 30 Clip



# INTERSECTION DRAWINGS CLASSIC TILE

HIP

SCALE 1:5

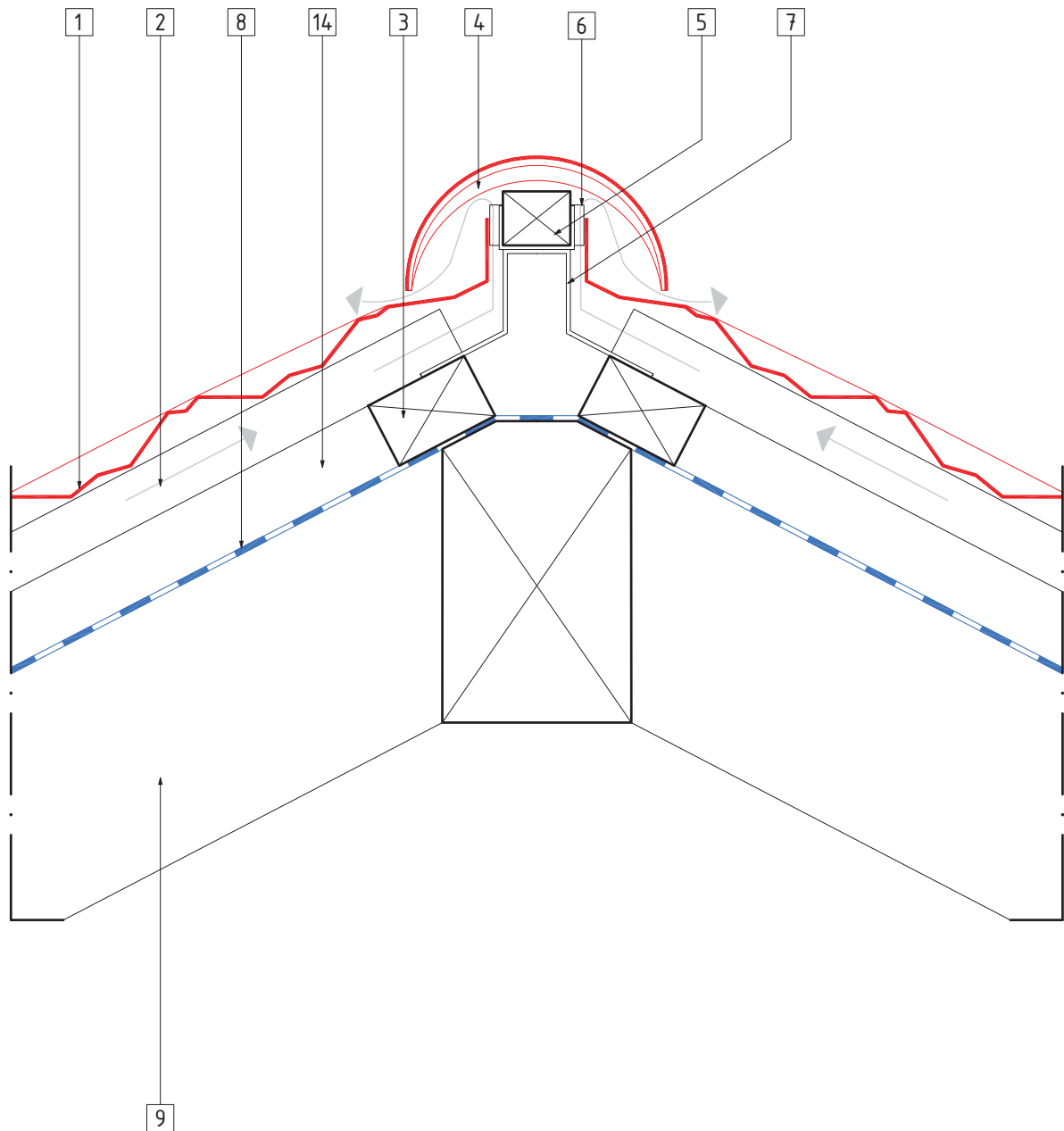

- 1 Tile
- 2 Tile Batten
- 3 Ventilation Space Batten
- 4 Barrel
- 5 Hip Batten
- 6 Spacer
- 7 Hip Bracket
- 8 Underlay
- 9 Rafter
- 14 Ventilation Space

# INTERSECTION DRAWINGS CLASSIC TILE

## CHIMNEY FLASHING

SCALE 1:10

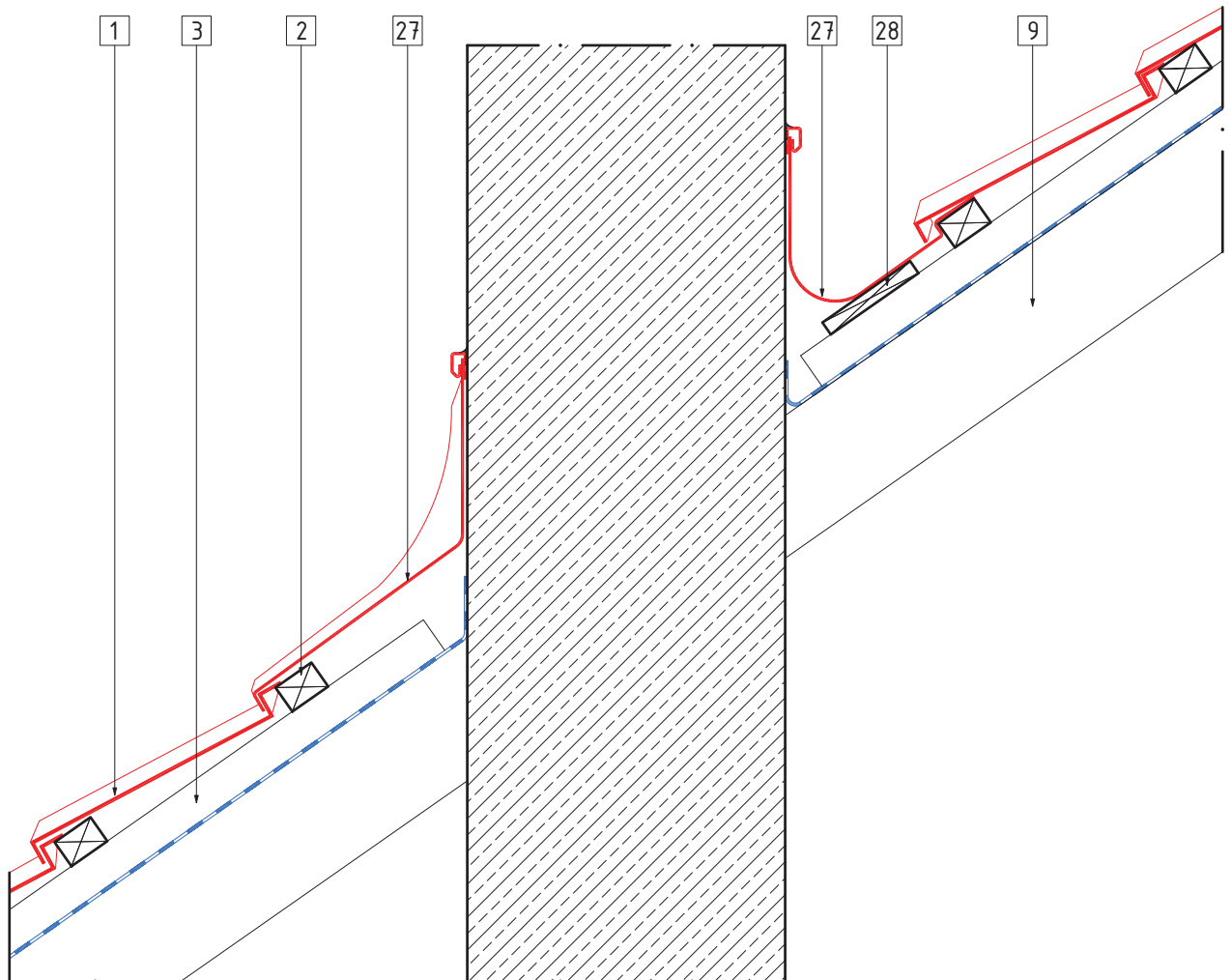

- 1 Tile
- 2 Tile Batten
- 3 Ventilation Space Batten
- 9 Rafter
- 27 Chimney Flashing
- 28 Board

# INTERSECTION DRAWINGS CLASSIC TILE

## CHIMNEY FLASHING

SCALE 1:10

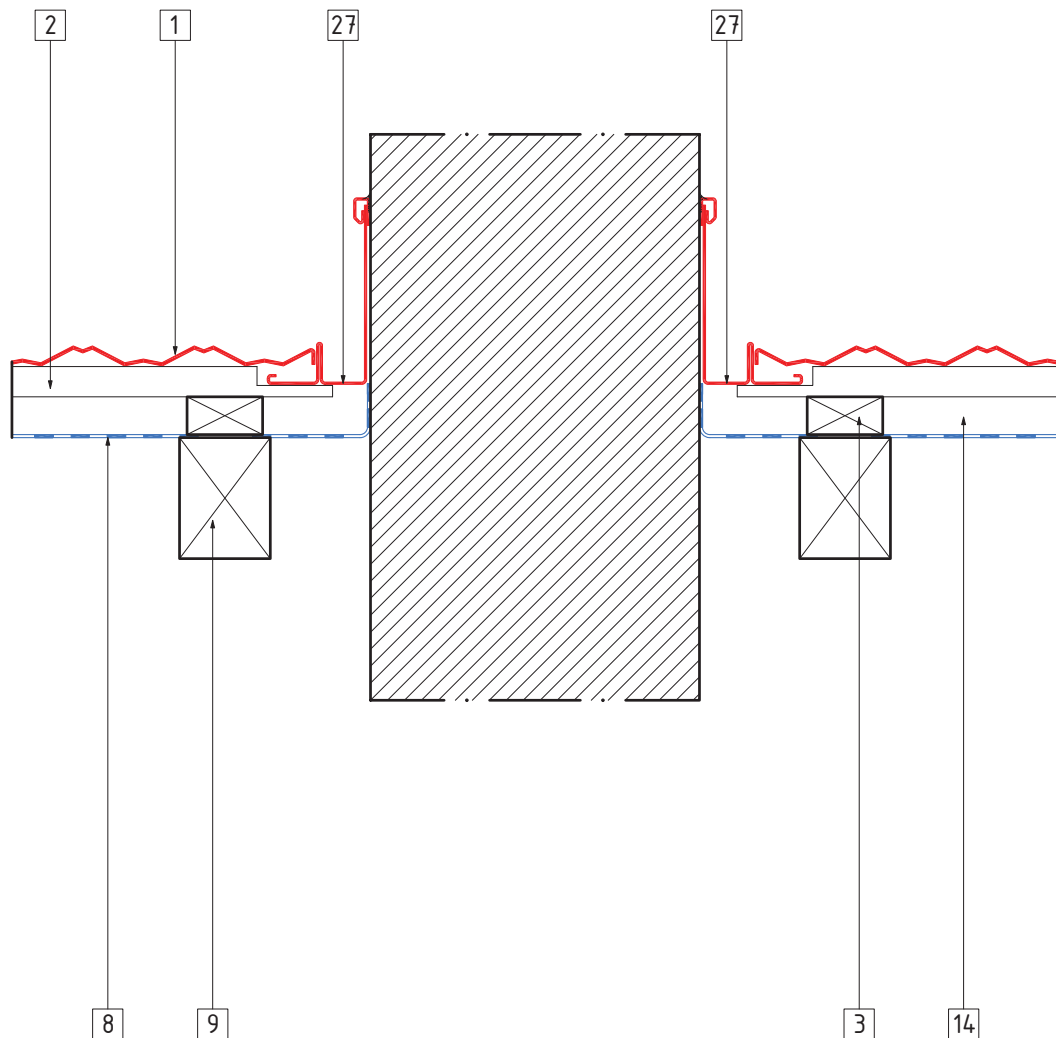

- 1 Tile
- 2 Tile Batten
- 3 Ventilation Space Batten
- 8 Underlay
- 9 Rafter
- 27 Chimney Flashing

# INTERSECTION DRAWINGS CLASSIC TILE

## TOP WALL FLASHING

SCALE 1:10

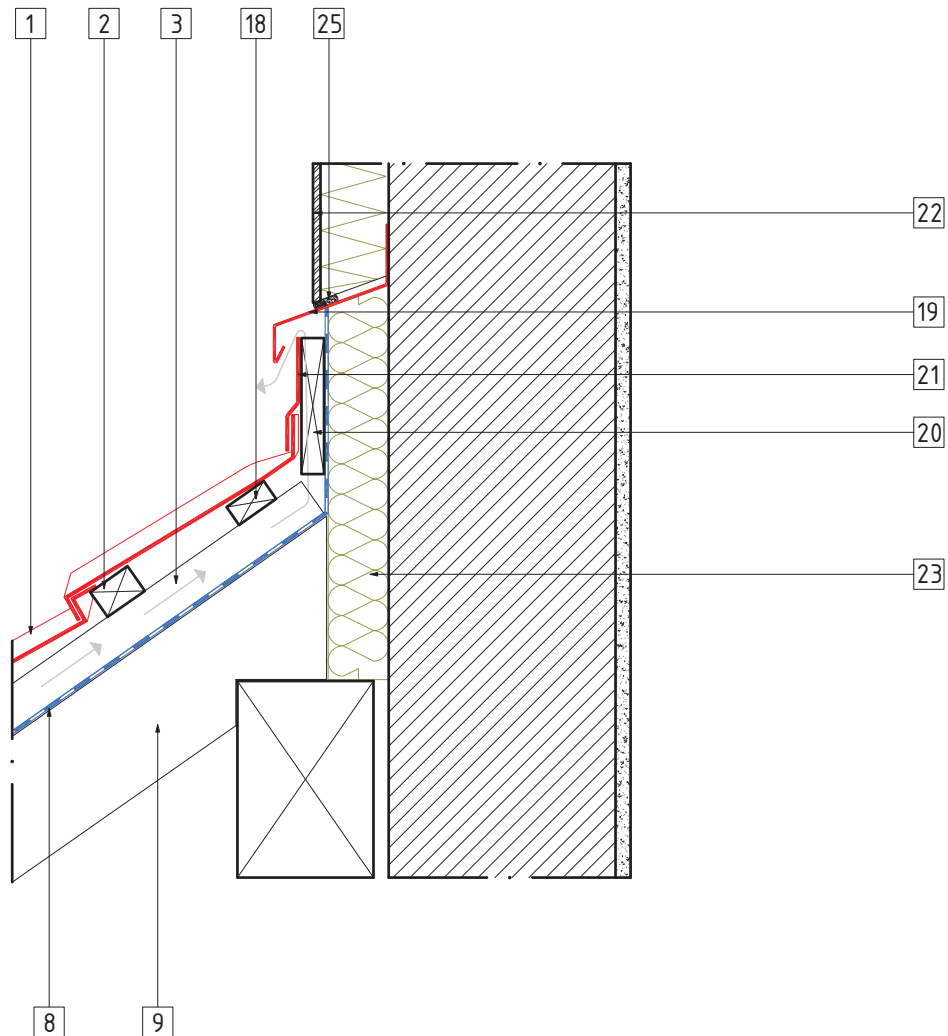

- 1 Tile
- 2 Tile Batten
- 3 Ventilation Space Batten
- 8 Underlay
- 9 Rafter
- 18 Support Batten
- 19 Top Wall Starter Flashing
- 20 Top Wall Spacer
- 21 Side Flashing
- 22 Render
- 23 Warmth Insulation
- 25 Sealant

# INTERSECTION DRAWINGS CLASSIC TILE

## TOP WALL FLASHING

SCALE 1:10

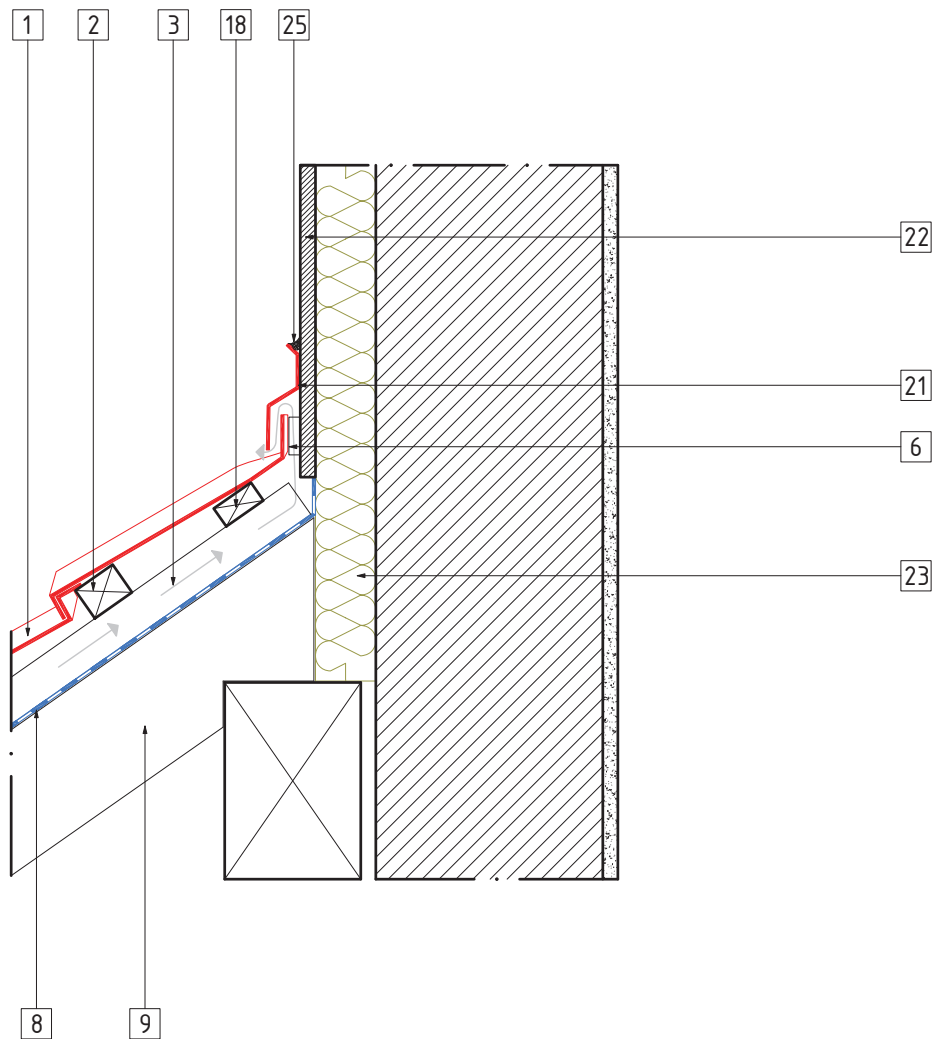

- 1 Tile
- 2 Tile Batten
- 3 Ventilation Space Batten
- 6 Spacer
- 8 Underlay
- 9 Rafter
- 18 Support Batten
- 21 Side Flashing
- 22 Render
- 23 Warmth Insulation
- 25 Sealant

# INTERSECTION DRAWINGS CLASSIC TILE

## WALL FLASHING

SCALE 1:10

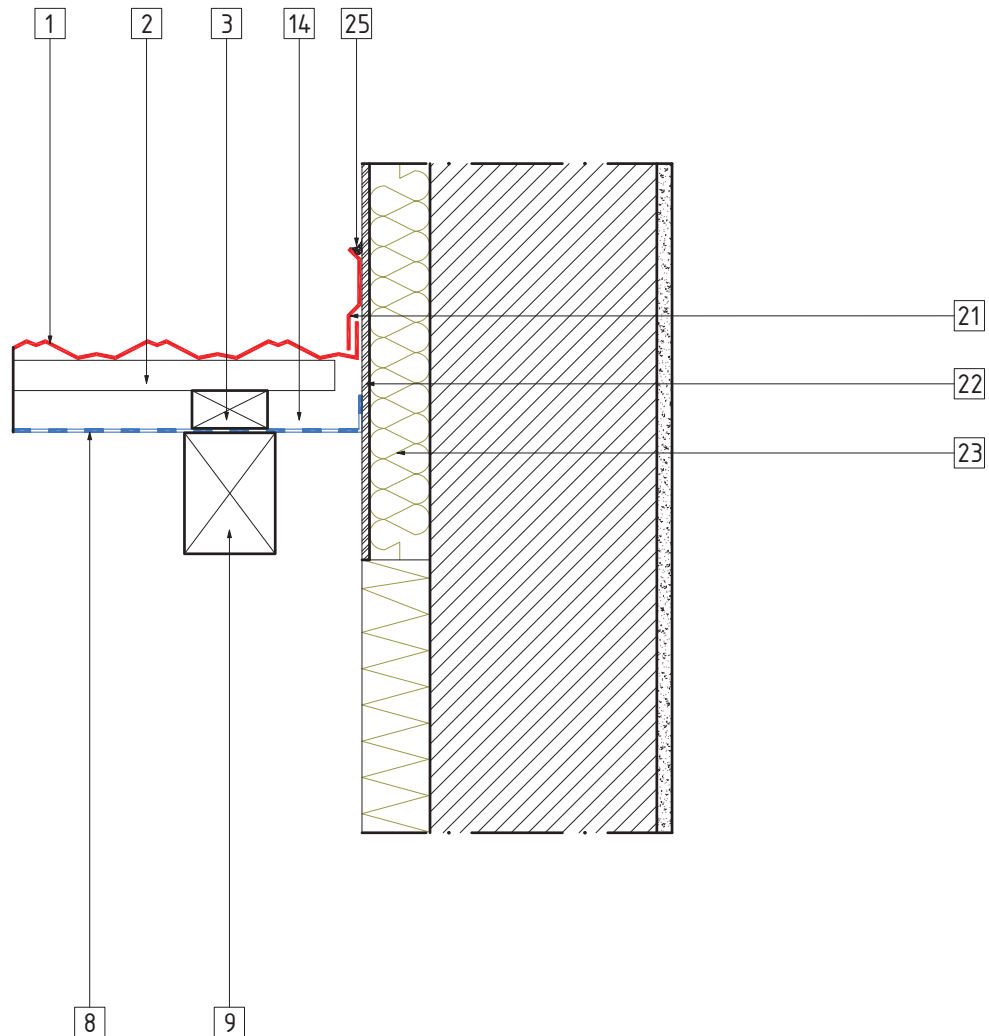

- 1 Tile
- 2 Tile Batten
- 3 Ventilation Space Batten
- 8 Underlay
- 9 Rafter
- 14 Ventilation Space
- 21 Side flashing
- 22 Render
- 23 Warmth Insulation
- 25 Sealant

# INTERSECTION DRAWINGS CLASSIC TILE

## WALL FLASHING

SCALE 1:10

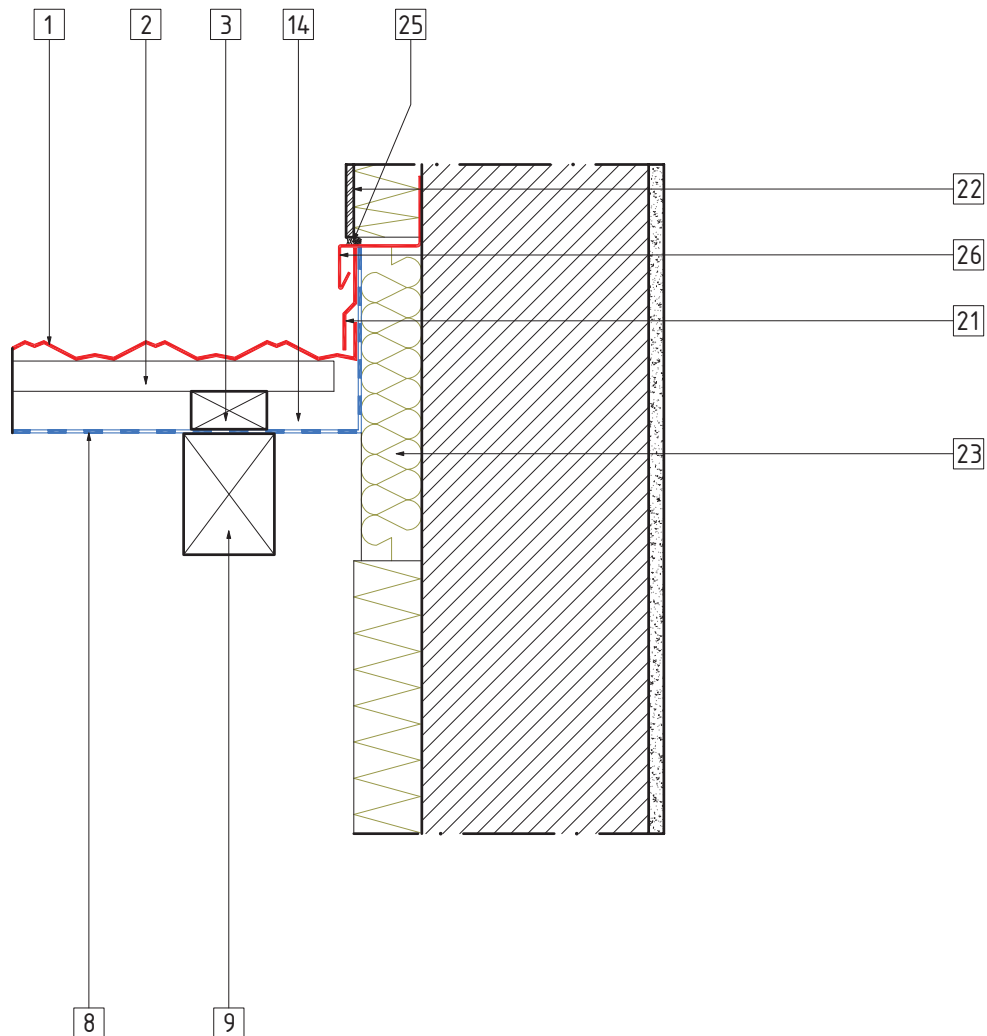

- 1 Tile
- 2 Tile Batten
- 3 Ventilation Space Batten
- 8 Underlay
- 9 Rafter
- 14 Ventilation Space
- 21 Side flashing
- 22 Render
- 23 Warmth Insulation
- 25 Sealant
- 26 Side Wall Starter Flashing